

Backwater pumping station, Pumpfix F DN 150, Floor slab, black

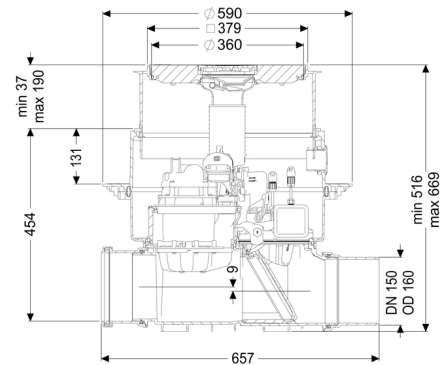

Article information

Item no.: 24150S
 GTIN: 4026092046562
 Price group: 30

Advantages

- Backwater pumping station: uses the natural fall to the sewer - pump is only used for backwater
- Flexible installation, different covers with drain function available for installation in the floor slab
- Quiet and energy-saving

Description

The premium backwater pumping station for faecal and non-faecal wastewater is equipped with a pump and a motor-driven closure system.

The pipe cross-section is normally open. In case of backwater, the motor-driven closure system is closed automatically. During the backwater phase, the water drains via the pump with integrated macerator.

The station is controlled by a user-friendly control unit, which is optionally integrated in the building management system via a potential-free contact, or alarm and collective fault messages can be output via a GSM interface.

Type of wastewater: wastewater with sewage
 Installation situation: floor slab installation

Version:

Odour trap: Multistop
 Emergency closure: yes
 Pump control: Control unit

Delivery state:	Pre-mounted for final assembly on site (pumps and sensor system must be fitted on site and control unit must be connected)
Number of motor-driven backwater flaps:	1

General characteristics:

Nominal size (DN):	150
Outer diameter (OD):	160
Colour:	black
Approval:	Z-53.2-388

Dimensions:

Length:	656 mm
Width:	590 mm
Cutout dimension, length:	750 mm
Cutout dimension, width:	750 mm

Tank:

Installation depth:	486 - 640 mm
Groundwater resistant from lower edge of base section:	3000 mm

Drain body:

Socket version:	including spigot and socket
Vertical adjustment:	vertically adjustable upper section

Coverage features:

Type of cover:	Cover plate with slotted cover
Cover material:	Polymer
Colour of cover:	black
Drainage function:	yes
Load class:	L 15 (EN 1253-1)
Length:	366 mm
Width:	366 mm
Locking:	Lock & Lift

Pumping device:

Pump:	SPZ 1000
Number of pumps:	1
Max. pumping capacity:	11.5 m ³ /h
Max. pumping height:	10 m
Operating mode:	S3 - 50 %
Power P1:	1.2 kW
Power P2:	0.69 kW
Speed:	2,800 U/min
Type of fuse required (electrical protection):	C 16 A
Max. temperature (permanent) of conveyed material:	40 °C
Connection type:	coded plug
Weight:	10 kg
Impeller type:	Macerator
Length of mains cable for pump:	5 m
Rated current:	5.2 A
Protection class (pump):	IP 68 (3m/48h)
Protection class:	I
Type of pump connection cable:	H07RN-F 3G 1.0 mm ²
Temperature monitoring:	integrated
Cos phi - power factor:	0.97
Insulation class:	F
Vertical drop between inlet and outlet:	9 mm
Motor type:	KSM 140
Protection class motor:	IP 68 (3m/48h)
Protection class probe:	IP 68 (3m/48h)

Control:

Control unit:	Comfort
Operating voltage:	230 V
Mains frequency:	50 Hz
Self-diagnosis system (SDS):	yes
Battery buffering:	yes
Multi-line display:	yes
Log book function:	yes
USB interface:	yes
GSM interface:	yes
Potential-free contact:	optional
Protection class control unit:	IP 54
Length of mains cable for control unit:	1.4 m
Type of level measurement:	optical
Level measurement instrument:	optical probe
Alarm sensor:	optical probe