

Lifting station Aqualift S 100 Tronic, GTF 600, Free-standing set-up

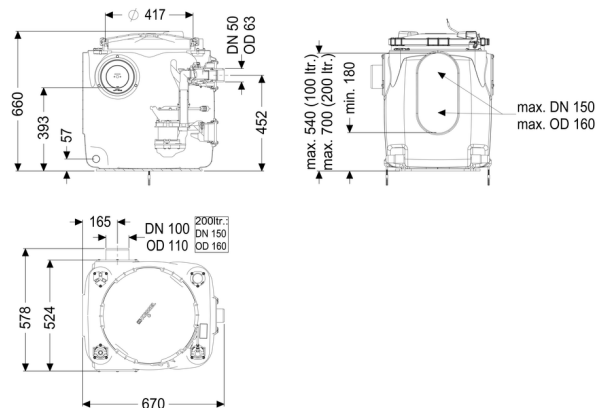

Article information

Item no.: 28513
 GTIN: 4026092092897
 Price group: 20

Advantages

- 1. With odour-tight cover and quick-release closure for easy maintenance
- 2. Tank made of PE, resistant to aggressive wastewater
- 3. Including backflow preventer for the pressure pipe

Description

Lifting station for faecal-free wastewater, free-standing set-up, preassembled for final installation on site.

- With odour-tight cover and quick-release closure for easy maintenance
- Tank made of PE, resistant to aggressive wastewater
- Including backflow preventer for the pressure pipe
- Including socket DN 100 for inlet and sampling
- Pump/s with multi-vane impeller for maximum operating reliability

Type of wastewater: wastewater without sewage
 Installation situation: free-standing set-up

Version:

Type of system: Single station
 Pump control: Control unit
 Backflow preventer: integrated

Delivery state: Pre-mounted for final assembly on site (pumps and sensor system must be fitted on site and control unit must be connected)

General characteristics:

Colour:	black
Standard:	EN 12050-2

Dimensions:

Length:	670 mm
Width:	530 mm
Height:	650 mm

Tank:

Inlet nominal size (DN):	100
Tank volume:	120 l
Pumping volume:	50 l
Pressure pipe connection (DN):	50 mm
Pressure pipe connection (OD):	63 mm

Coverage features:

Type of cover:	Cover
Cover material:	Polymer
Colour of cover:	violet
Tightness:	odour-tight
Locking:	Quick-release closure
Free passage:	10 mm

Pumping device:

Pump:	GTF 600
Number of pumps:	1
Max. pumping capacity:	12 m ³ /h
Max. pumping height:	8 m
Operating voltage:	230 V
Mains frequency:	50 Hz
Operating mode:	S1
Power P1:	0.65 kW
Power P2:	0.4 kW
Speed:	2,750 U/min
Type of fuse required (electrical protection):	C 16 A
Max. temperature (permanent) of conveyed material:	40 °C
Connection type:	coded plug
Weight:	6 kg

Impeller type:	Multi-vane impeller
Length of mains cable for pump:	5 m
Rated current:	2.9 A
Protection class (pump):	IP 68 (3m)
Protection class:	I
Type of pump connection cable:	H07RN-F 3G 1.0 mm ²
Temperature monitoring:	integrated
Insulation class:	F

Control:

Control unit:	Comfort
Operating voltage:	230 V
Mains frequency:	50 Hz
Self-diagnosis system (SDS):	yes
Battery buffering:	yes
Multi-line display:	yes
Log book function:	yes
USB interface:	yes
GSM interface:	yes
Potential-free contact:	optional
Motor protection switch:	yes
Protection class control unit:	IP 54
Length of mains cable for control unit:	1.4 m
Type of level measurement:	pneumatic
Alarm sensor:	Immersion pipe