

Controlfix clean out DN 125, Floor slab, tileable

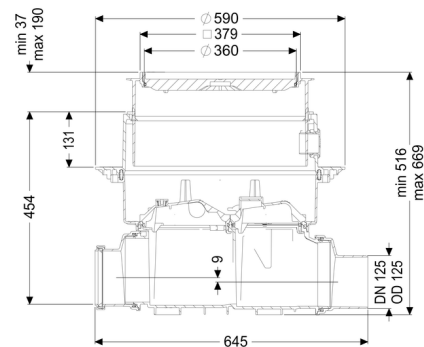

Article information

Item no.: 80125X
 GTIN: 4026092004081
 Price group: 30

Advantages

- Simple conversion to Staufix SWA
- Staufix FKA or Pumpfix F
- Fast
- toolless access for cleaning
- Available as a complete set or module set

Description

The Premium clean out for faecal and faecal-free wastewater makes easy access to wastewater pipes possible for inspection and maintenance work.

Thanks to the modular KESSEL system, existing systems can easily be converted to a Staufix SWA Premium backwater valve, Staufix FKA or Pumpfix F backwater pumping station.

Type of wastewater: wastewater with and without sewage
 Installation situation: floor slab installation

Version:

Type of waterproofing layer: Waterproofing layer

Delivery state: Installation-ready (connection parts must be connected on site)

General characteristics:

Nominal size (DN): 125
 Outer diameter (OD): 125
 Colour: black

Dimensions:

Length:	486 mm
Width:	590 mm
Cutout dimension, length:	750 mm
Cutout dimension, width:	750 mm

Tank:

Installation depth:	486 - 640 mm
Groundwater resistant from lower edge of base section:	3,000 mm

Drain body:

Socket version:	including spigot and socket
Vertical adjustment:	vertically adjustable upper section

Coverage features:

Type of cover:	tileable cover plate
Cover material:	Polymer
Max. flooring height:	16 mm
Load class:	K 3 (EN 1253-1)
Length:	366 mm
Width:	366 mm
Tightness:	surface water resistant
Locking:	Lock & Lift
Vertical drop between inlet and outlet:	9 mm